

Genie®

Operator's Manual *with Maintenance Information*

Third Edition
Second Printing
Part No. 82282

ZTM-30/20N

Important

Read, understand and obey these safety rules and operating instructions before operating this machine. Only trained and authorized personnel shall be permitted to operate this machine. This manual should be considered a permanent part of your machine and should remain with the machine at all times. If you have any questions, call Genie Industries.

Contents

	Page
Safety	1
Controls	8
Pre-operation Inspection	10
Maintenance	12
Function Tests	14
Workplace Inspection	19
Operating Instructions	20
Transport and Lifting Instructions	25
Decals	28
Specifications	32

Contact us:

Internet: <http://www.genielift.com>
 e-mail: techpub@genieind.com

Copyright © 1995 by Genie Industries

First Edition: Fourth Printing, August 1996

Second Edition: Fourth Printing, July 2000

Third Edition: Second Printing, January 2004

"Genie" and "Z" are registered trademarks of Genie Industries in the USA and many other countries.

These machines comply with ANSI/SIA 92.5-1992.

 Printed on recycled paper

Printed in U.S.A.

Safety Rules



Danger

Failure to obey the instructions and safety rules in this manual will result in death or serious injury.

Do Not Operate Unless:

- You learn and practice the principles of safe machine operation contained in this operator's manual.
 - 1 Avoid hazardous situations.**
 - Know and understand the safety rules before going on to the next section.**
 - 2 Always perform a pre-operation inspection.
 - 3 Always perform function tests prior to use.
 - 4 Inspect the workplace.
 - 5 Only use the machine as it was intended.
- You read, understand and obey the manufacturer's instructions and safety rules—safety and operator's manuals and machine decals.
- You read, understand and obey employer's safety rules and worksite regulations.
- You read, understand and obey all applicable governmental regulations.
- You are properly trained to safely operate the machine.

SAFETY RULES

Electrocution Hazards

This machine is **not** electrically insulated and will **not** provide protection from contact with or proximity to electrical current.

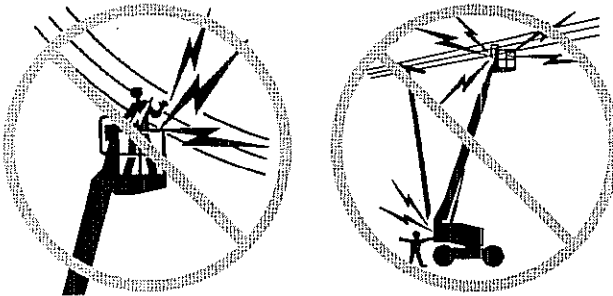

Maintain safe distances from electrical power lines and apparatus in accordance with applicable governmental regulations and the following chart.

Voltage Phase to Phase	Minimum Safe Approach Distance	
	Feet	Meters
0 to 300V	Avoid Contact	
300V to 50KV	10	3.05
50KV to 200KV	15	4.60
200KV to 350KV	20	6.10
350KV to 500KV	25	7.62
500KV to 750KV	35	10.67
750KV to 1000KV	45	13.72

Allow for platform movement, electrical line sway or sag, and beware of strong or gusty winds.

Keep away from the machine if it contacts energized power lines. Personnel on the ground or in the platform must not touch or operate the machine until energized power lines are shut off.

Do not operate the machine during lightning or storms.

Do not use the machine as a ground for welding.

Tip-over Hazards

Occupants, equipment and materials shall not exceed the maximum platform capacity.

Maximum platform capacity	500 lbs	227 kg
Maximum occupants	2	

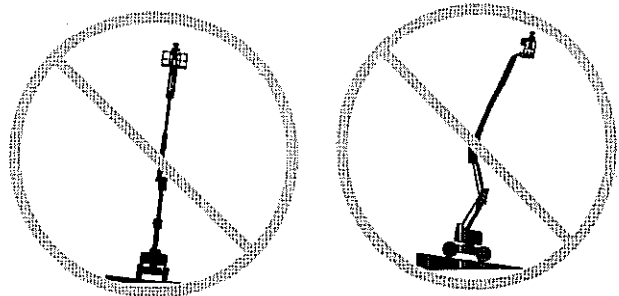

Do not raise or extend the boom unless the machine is on a firm, level surface.

Do not depend on the tilt alarm as a level indicator. The tilt alarm sounds in the platform only when the machine is on a severe slope.

If the tilt alarm sounds:

Do not extend, rotate or raise the boom above horizontal. Move the machine to a firm, level surface before raising the platform. If the tilt alarm sounds when the platform is raised, use extreme caution to retract the boom and lower the platform. Do not rotate the boom while lowering. Move the machine to a firm, level surface before raising the platform.

SAFETY RULES

Do not alter or disable the limit switches.

Do not drive over 0.6 mph / 1 km/h with the primary boom raised or extended or the secondary boom raised.

Do not use the platform controls to free a platform that is caught, snagged or otherwise prevented from normal motion by an adjacent structure. All personnel must be removed from the platform before attempting to free the platform using the ground controls.

Do not operate the machine in strong or gusty winds. Do not increase the surface area of the platform or the load. Increasing the area exposed to the wind will decrease machine stability.

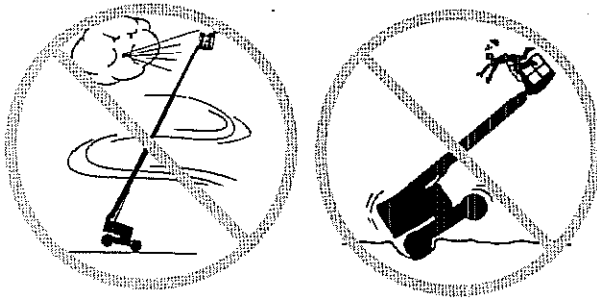

Use extreme care and slow speeds while driving the machine in the stowed position across uneven terrain, debris, unstable or slippery surfaces and near holes and drop-offs.

Do not drive the machine on or near uneven terrain, unstable surfaces or other hazardous conditions with the boom raised or extended.

Do not push off or pull toward any object outside of the platform.

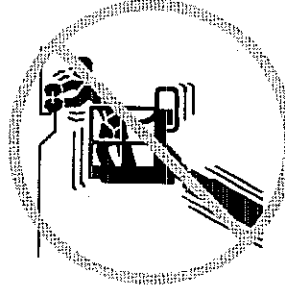

Maximum allowable side force - ANSI & CSA
150 lbs / 667 N

Maximum allowable side force - CE
90 lbs / 400 N

Do not alter or disable machine components that in any way affect safety and stability.

Do not replace items critical to machine stability with items of different weight or specification.

Do not modify or alter an aerial work platform without prior written permission from the manufacturer. Mounting attachments for holding tools or other materials onto the platform, toeboards or guard rail system can increase the weight in the platform and the surface area of the platform or the load.

Do not place or attach overhanging loads to any part of this machine.

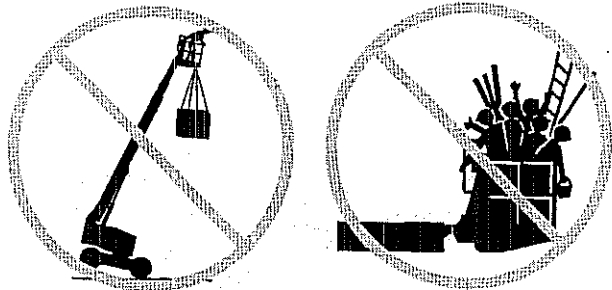

Do not place ladders or scaffolds in the platform or against any part of this machine.

SAFETY RULES

Do not transport tools and materials unless they are evenly distributed and can be safely handled by person(s) in the platform.

Do not use the machine on a moving or mobile surface or vehicle.

Be sure all tires are in good condition and lug nuts are properly tightened.

Do not use batteries that weigh less than the original equipment. Batteries are used as counterweight and are critical to machine stability. Each battery must weigh 105 pounds / 47.6 kg. Each battery box including batteries must weigh a minimum of 530 pounds / 240.4 kg.

Do not use the machine as a crane.

Do not push the machine or other objects with the boom.

Do not contact adjacent structures with the boom.

Do not tie the boom or platform to adjacent structures.

Do not place loads outside the platform perimeter.

Fall Hazards

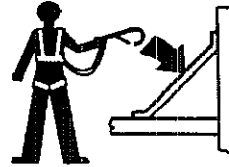

Occupants must wear a safety belt or harness and comply with applicable governmental regulations. Attach lanyard to the anchor provided in the platform.

Do not sit, stand or climb on the platform guard rails. Maintain a firm footing on the platform floor at all times.

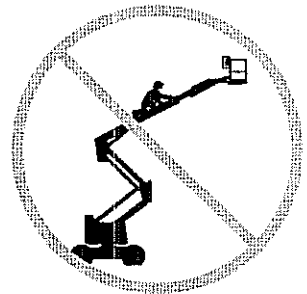

Do not climb down from the platform when raised.

Keep the platform floor clear of debris.

Lower the platform entry mid-rail or close the entry gate before operating.

SAFETY RULES

Collision Hazards

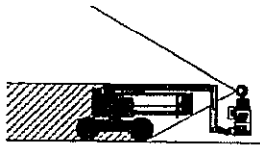

Be aware of limited sight distance and blind spots when driving or operating.

Be aware of boom position when rotating the turntable.

Check the work area for overhead obstructions or other possible hazards.



Be aware of crushing hazards when grasping the platform guard rail.

Operators must comply with employer, job site and governmental rules regarding the use of personal protective equipment.

Observe and use the color-coded direction arrows on the platform controls and drive chassis for drive and steer functions.

Do not lower the boom unless the area below is clear of personnel and obstructions.

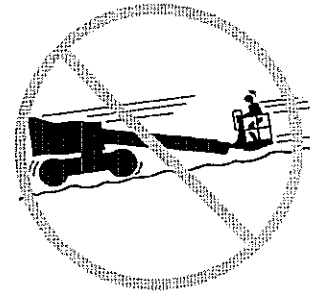
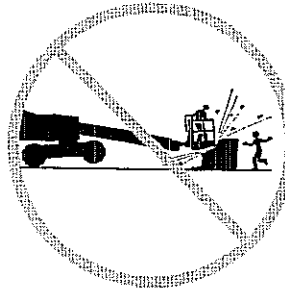

Limit travel speed according to the condition of the ground surface, congestion, slope, location of personnel, and any other factors which may cause collision.

Do not operate a boom in the path of any crane unless the controls of the crane have been locked out and/or precautions have been taken to prevent any potential collision.

No stunt driving or horseplay while operating a machine.

SAFETY RULES

Component Damage Hazard

Do not use the machine as a ground for welding.

Damaged Machine Hazards

Do not use a damaged or malfunctioning machine.

Conduct a thorough pre-operation inspection of the machine and test all functions before each work shift. Immediately tag and remove from service a damaged or malfunctioning machine.

Be sure all maintenance has been performed as specified in this manual and the *Genie Z-30/20N Service Manual*.

Be sure all decals are in place and legible.

Be sure the operator's, safety and responsibilities manuals are complete, legible and in the storage container located on the platform.

Bodily Injury Hazard

Do not operate the machine with a hydraulic oil or air leak. An air leak or hydraulic leak can penetrate and/or burn skin.

Improper contact with components under any cover will cause serious injury. Only trained maintenance personnel should access compartments. Access by the operator is only advised when performing a pre-operation inspection. All compartments must remain closed and secured during operation.

Decal Legend

Genie product decals use symbols, color coding and signal words to identify the following:



Safety alert symbol—used to alert personnel to potential personal injury hazards. Obey all safety messages that follow this symbol to avoid possible injury or death.



Red—used to indicate the presence of an imminently hazardous situation which, if not avoided, will result in death or serious injury.



Orange—used to indicate the presence of a potentially hazardous situation which, if not avoided, could result in death or serious injury.



Yellow with safety alert symbol—used to indicate the presence of a potentially hazardous situation which, if not avoided, may cause minor or moderate injury.



Yellow without safety alert symbol—used to indicate the presence of a potentially hazardous situation which, if not avoided, may result in property damage.



Green—used to indicate operation or maintenance information.

SAFETY RULES

Battery Safety

Burn Hazards

Batteries contain acid. Always wear protective clothing and eyewear when working with batteries.

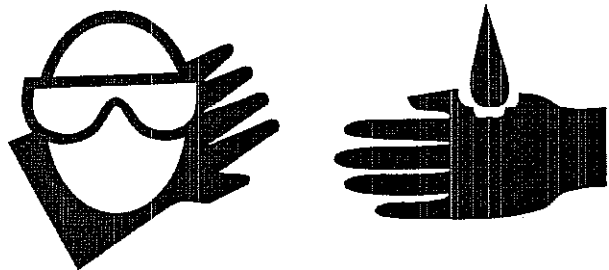

Avoid spilling or contacting battery acid. Neutralize battery acid spills with baking soda and water.

The battery pack must remain in an upright position.

Do not expose the batteries or the charger to water or rain.

Explosion Hazards



Keep sparks, flames and lighted tobacco away from batteries. Batteries emit an explosive gas.

The battery pack cover must remain off during the entire charging cycle.

Do not contact the battery terminals or the cable clamps with tools that may cause sparks.

Component Damage Hazards

Do not use any battery charger greater than 48V to charge the batteries.

Both battery packs must be charged together.

Disconnect the battery pack plug before removing the battery pack.

Electrocution Hazards



Connect the battery charger to a grounded, AC 3-wire electrical outlet only.

Inspect daily for damaged cord, cables and wires. Replace damaged items before operating.

Avoid electrical shock from contact with battery terminals. Remove all rings, watches and other jewelry.

Tip-over Hazard

Do not use batteries that weigh less than the original equipment. Batteries are used as counterweight and are critical to machine stability. Each battery must weigh 105 pounds / 47.6 kg. Each battery box including batteries must weigh a minimum of 530 pounds / 240.4 kg.

Lifting Hazard

Use a forklift to remove or install the battery packs.

Controls

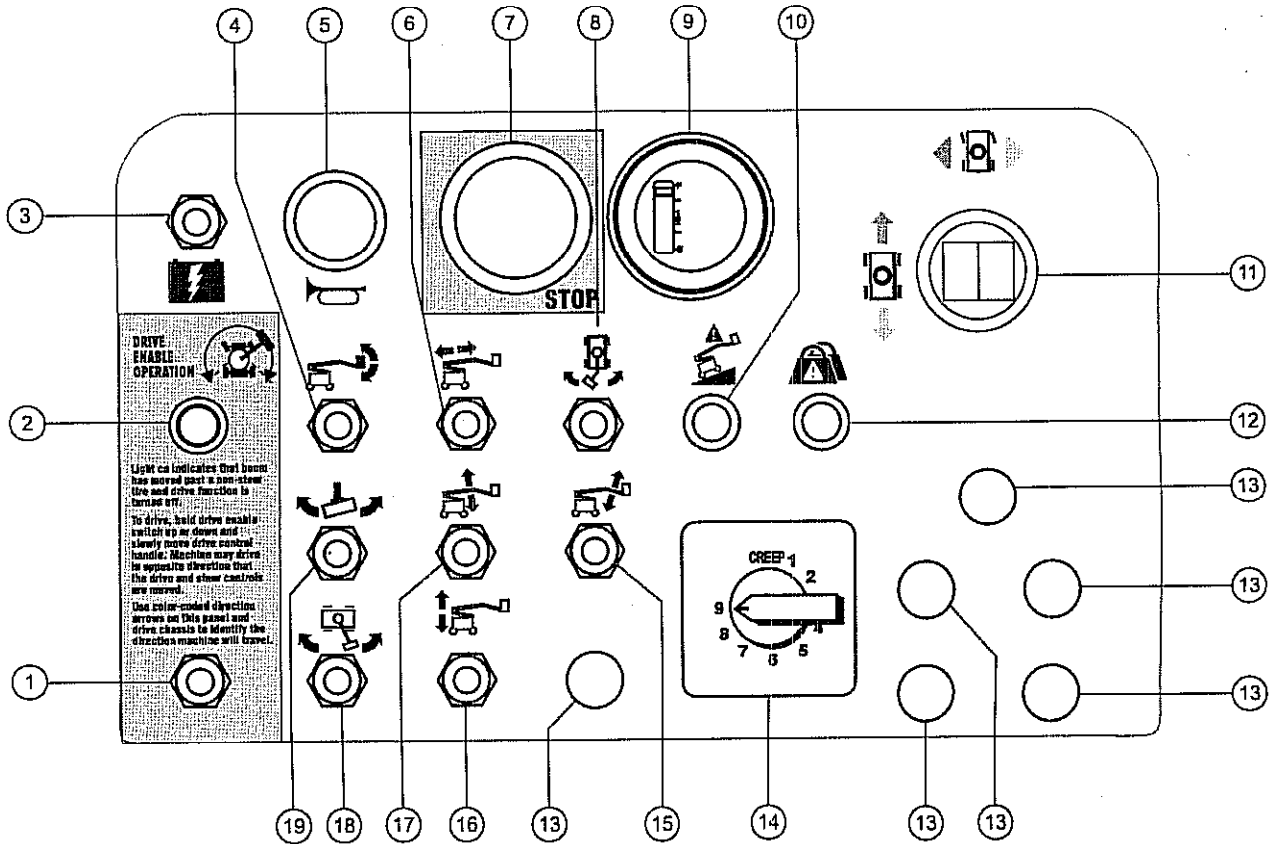

Platform Control Panel

- | | |
|---|--|
| <ul style="list-style-type: none"> 1 Drive enable switch 2 Drive enable indicator light 3 Auxiliary power switch 4 Platform level switch 5 Horn button 6 Primary boom extend/retract switch 7 Red Emergency Stop button 8 Jib boom rotate switch (option) 9 Battery charge indicator and/or low voltage interrupt (option) 10 Machine not level indicator light (if equipped) | <ul style="list-style-type: none"> 11 Proportional control handle for drive function and thumb rocker for steer function 12 Platform overload indicator light (if equipped) 13 Not used 14 Boom function speed controller 15 Jib boom up/down switch 16 Secondary boom up/down switch 17 Primary boom up/down switch 18 Turntable rotate switch 19 Platform rotate switch |
|---|--|

CONTROLS

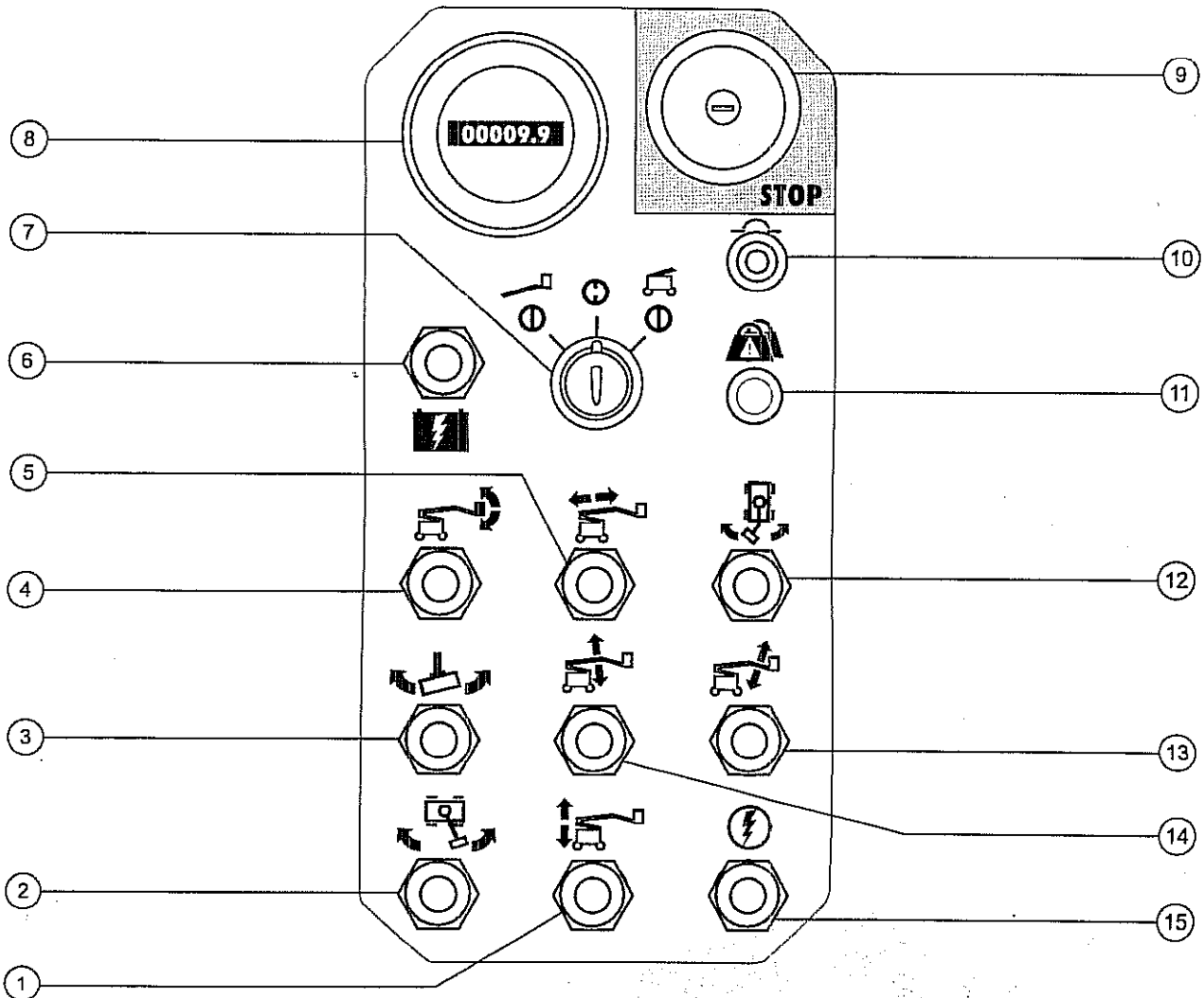

Ground Control Panel

- | | |
|--|--|
| 1 Secondary boom up/down switch | 9 Red Emergency Stop button |
| 2 Turntable rotate switch | 10 10A breaker for electrical circuits |
| 3 Platform rotate switch | 11 Platform overload indicator light (if equipped) |
| 4 Platform level switch | 12 Jib boom rotate switch (option) |
| 5 Primary boom extend/retract switch | 13 Jib boom up/down switch |
| 6 Auxiliary power switch | 14 Primary boom up/down switch |
| 7 Key switch for platform/off/ground selection | 15 Function enable switch |
| 8 Hour meter | |

Pre-operation Inspection

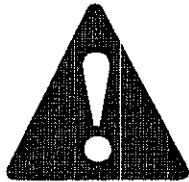

Do Not Operate Unless:

- You learn and practice the principles of safe machine operation contained in this operator's manual.
 - 1 Avoid hazardous situations.
 - 2 Always perform a pre-operation inspection.**
- Know and understand the pre-operation inspection before going on to the next section.**
- 3 Always perform function tests prior to use.
- 4 Inspect the workplace.
- 5 Only use the machine as it was intended.

Fundamentals

It is the responsibility of the operator to perform a pre-operation inspection and routine maintenance.

The pre-operation inspection is a visual inspection performed by the operator prior to each work shift. The inspection is designed to discover if anything is apparently wrong with a machine before the operator performs the function tests.

The pre-operation inspection also serves to determine if routine maintenance procedures are required. Only routine maintenance items specified in this manual may be performed by the operator.

Refer to the list on the next page and check each of the items.

If damage or any unauthorized variation from factory delivered condition is discovered, the machine must be tagged and removed from service.

Repairs to the machine may only be made by a qualified service technician, according to the manufacturer's specifications. After repairs are completed, the operator must perform a pre-operation inspection again before going on to the function tests.

Scheduled maintenance inspections shall be performed by qualified service technicians, according to the manufacturer's specifications and the requirements listed in the responsibilities manual.

PRE-OPERATION INSPECTION

Pre-operation Inspection

- Be sure that the operator's, safety and responsibilities manuals are complete, legible and in the storage container located on the platform.
- Be sure that all decals are legible and in place. See Decals section.
- Check for hydraulic oil leaks and proper oil level. Add oil if needed. See Maintenance section.
- Check for battery fluid leaks and proper fluid level. Add distilled water if needed. See Maintenance section.

Check the following components or areas for damage, improperly installed or missing parts and unauthorized modifications:

- Electrical components, wiring and electrical cables
- Hydraulic power unit, reservoir, hoses, fittings, cylinders and manifolds
- Drive and turntable motors and drive hubs
- Boom wear pads
- Tires and wheels
- Limit switches, alarms and horn
- Nuts, bolts and other fasteners
- Platform entry mid-rail/gate
- Beacon and alarms (if equipped)

Check entire machine for:

- Cracks in welds or structural components
- Dents or damage to machine
- Be sure that all structural and other critical components are present and all associated fasteners and pins are in place and properly tightened.
- Be sure that both battery packs are in place, latched and properly connected.
- After you complete your inspection, be sure that all compartment covers are in place and latched.

Maintenance

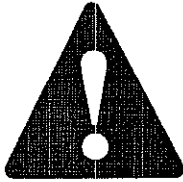

Observe and Obey:

- Only routine maintenance items specified in this manual shall be performed by the operator.
- Scheduled maintenance inspections shall be completed by qualified service technicians, according to the manufacturer's specifications and the requirements specified in the responsibilities manual.

Maintenance Symbols Legend



The following symbols have been used in this manual to help communicate the intent of the instructions. When one or more of the symbols appear at the beginning of a maintenance procedure, it conveys the meaning below.



Indicates that tools will be required to perform this procedure.



Indicates that new parts will be required to perform this procedure.

Check the Hydraulic Oil Level



Maintaining the hydraulic oil at the proper level is essential to machine operation. Improper hydraulic oil levels can damage hydraulic components. Daily checks allow the inspector to identify changes in oil level that might indicate the presence of hydraulic system problems.

- 1 Be sure that the boom is in the stowed position, then visually inspect the reservoir on the hydraulic power unit.
- ⊙ Result: The hydraulic oil level should be within the FULL and ADD marks on the hydraulic reservoir.

Hydraulic oil specifications

Hydraulic oil type

Chevron Rykon
Premium MV equivalent

MAINTENANCE

Check the Batteries



Proper battery condition is essential to good machine performance and operational safety. Improper fluid levels or damaged cables and connections can result in component damage and hazardous conditions.

⚠ WARNING Electrocutation hazard. Contact with hot or live circuits could result in death or serious injury. Remove all rings, watches and other jewelry.

⚠ WARNING Bodily injury hazard. Batteries contain acid. Avoid spilling or contacting battery acid. Neutralize battery acid spills with baking soda and water.

NOTE Perform this test after fully charging the batteries.

- 1 Put on protective clothing and eye wear.
- 2 Be sure that the battery cable connections are tight and free of corrosion.
- 3 Remove the battery vent caps.
- 4 Check the battery acid level. If needed, replenish with distilled water to the bottom of the battery fill tube. Do not overfill.
- 5 Install the vent caps.

Scheduled Maintenance

Maintenance performed quarterly, annually and every two years must be completed by a person trained and qualified to perform maintenance on this machine according to the procedures found in the service manual for this machine.

Machines that have been out of service for more than three months must receive the quarterly inspection before they are put back into service.

Function Tests



Do Not Operate Unless:

- You learn and practice the principles of safe machine operation contained in this operator's manual.
 - 1 Avoid hazardous situations.
 - 2 Always perform a pre-operation inspection.
 - 3 Always perform function tests prior to use.**
- Know and understand the function tests before going on to the next section.**
- 4 Inspect the workplace.
 - 5 Only use the machine as it was intended.

Fundamentals

The function tests are designed to discover any malfunctions before the machine is put into service. The operator must follow the step-by-step instructions to test all machine functions.

A malfunctioning machine must never be used. If malfunctions are discovered, the machine must be tagged and removed from service. Repairs to the machine may only be made by a qualified service technician, according to the manufacturer's specifications.

After repairs are completed, the operator must perform a pre-operation inspection and function tests again before putting the machine into service.

- 1 Select a test area that is firm, level and free of obstruction.

At the Ground Controls

- 2 Turn the key switch to ground control.
- 3 Pull out the red Emergency Stop button to the on position.
- ⊙ Result: The beacon (if equipped) should flash.

Test Emergency Stop

- 4 Push in the red Emergency Stop button to the off position.
- ⊙ Result: All ground and platform control functions should not operate.
- 5 Pull out the red Emergency Stop button to the on position.

FUNCTION TESTS

Test the Boom Functions

- 6 Do not hold the function enable switch to either side. Attempt to activate each boom and platform function toggle switch.
- ⊙ Result: All boom and platform functions should not operate.
- 7 Hold the function enable switch to either side and activate each boom and platform function toggle switch.
- ⊙ Result: All boom and platform functions should operate through a full cycle. The descent alarm (if equipped) should sound while the boom is lowering.



Machines equipped with Platform Level Control Disable Function: The platform level toggle switch will not operate when the primary boom is raised past the drive speed limit switch.

Test the Tilt Sensor

- 8 Pull out the platform red Emergency Stop button to the on position. Turn the key switch to platform control.
- 9 Open the ground control side turntable cover and locate the tilt sensor next to the function manifold.
- 10 Press down one side of the tilt sensor.
- ⊙ Result: The alarm, located in the platform, should sound.

**Test Auxiliary Controls**

- 11 Turn the key switch to ground control.
- 12 Simultaneously hold the auxiliary power switch on and activate each boom function toggle switch.



Note: To conserve battery power, test each function through a partial cycle.

- ⊙ Result: All boom functions should operate.
- 13 Turn the key switch to platform control.

At the Platform Controls**Test Emergency Stop**

- 14 Push in the platform red Emergency Stop button to the off position.
- ⊙ Result: All platform control functions should not operate.

Test the Horn

- 15 Pull out the red Emergency Stop button to the on position.
- 16 Push the horn button.
- ⊙ Result: The horn should sound.

Test the Foot Switch

- 17 Do not press down the foot switch. Activate each machine function.
- ⊙ Result: The machine functions should not operate.

FUNCTION TESTS**Test Machine Functions**

- 18 Press down the foot switch.
- 19 Activate each machine function toggle switch.
- ⊙ Result: All boom/platform functions should operate through a full cycle.

Note: Control the speed of boom functions by adjusting the boom function speed controller. Drive and steer functions are not affected by the boom function speed controller.

Machines equipped with Platform Level Control Disable Function: The platform level toggle switch will not operate when the primary boom is raised past the drive speed limit switch.

Test the Steering

- 20 Press down the foot switch.
- 21 Depress the thumb rocker switch on top of the drive control handle in the direction identified by the blue triangle on the control panel.
- ⊙ Result: The steer wheels should turn in the direction that the blue triangles point on the drive chassis.
- 22 Depress the thumb rocker switch in the direction identified by the yellow triangle on the control panel.
- ⊙ Result: The steer wheels should turn in the direction that the yellow triangles point on the drive chassis.

Test Drive and Braking

- 23 Press down the foot switch.
- 24 Slowly move the drive control handle in the direction indicated by the blue arrow on the control panel until the machine begins to move, then return the handle to the center position.
- ⊙ Result: The brake release alarm should sound. The machine should move in the direction that the blue arrow points on the drive chassis, then come to an abrupt stop.
- 25 Slowly move the drive control handle in the direction indicated by the yellow arrow on the control panel until the machine begins to move, then return the handle to the center position.
- ⊙ Result: The brake release alarm should sound. The machine should move in the direction that the yellow arrow points on the drive chassis, then come to an abrupt stop.

Note: The brakes must be able to hold the machine on any slope it is able to climb.

FUNCTION TESTS

Test Limited Drive Speed

26 Press down the foot switch.

27 Raise the primary boom 1 foot / 30 cm.

28 Slowly move the drive control handle to the full drive position.

- ⊙ Result: The maximum achievable drive speed with the primary boom raised should not exceed 1 foot / 30 cm per second.

29 Lower the boom to the stowed position.

30 Raise the secondary boom 1 foot / 30 cm.

31 Slowly move the drive control handle to the full drive position.

- ⊙ Result: The maximum achievable drive speed with the secondary boom raised should not exceed 1 foot / 30 cm per second.

32 Lower the boom to the stowed position.

33 Extend the primary boom 1 foot / 30 cm.

34 Slowly move the drive control handle to the full drive position.

- ⊙ Result: The maximum achievable drive speed with the primary boom extended should not exceed 1 foot / 30 cm per second.

If the drive speed with the primary boom raised or extended or the secondary boom raised exceeds 1 foot / 30 cm per second, immediately tag and remove the machine from service.

Test the Drive Enable System

35 Press down the foot switch and retract the primary boom to the stowed position.

36 Rotate the turntable until the boom moves past one of the non-steer wheels.

- ⊙ Result: The drive enable indicator light should come on and remain on while the boom is anywhere in the range shown.



37 Move the drive control handle off center.

- ⊙ Result: The drive function should not operate.

38 Hold the drive enable toggle switch up or down and slowly move the drive control handle off center.

- ⊙ Result: The drive function should operate.

Note: When the drive enable system is in use, the machine may drive in the opposite direction that the drive and steer control handle is moved.

Use the color-coded direction arrows on the platform controls and the drive chassis to identify the direction of travel.

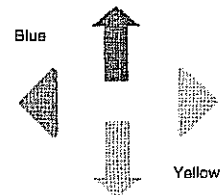

FUNCTION TESTS

Test Auxiliary Controls

- 41 Press down the foot switch.
- 42 Simultaneously hold the auxiliary power switch on and activate each function control handle or toggle switch.

Note: To conserve battery power, test each function through a partial cycle.

- ⊙ Result: All boom, steer and drive functions should operate.

Test the Lift/Drive Select Function (if equipped)

- 39 Press down the foot switch.
 - 40 Move the drive control handle off center and activate a boom function toggle switch.
- ⊙ Result: No boom functions should operate. The machine will move in the direction indicated on the control panel.

Workplace Inspection



Do Not Operate Unless:

- You learn and practice the principles of safe machine operation contained in this operator's manual.

- 1 Avoid hazardous situations.
- 2 Always perform a pre-operation inspection.
- 3 Always perform function tests prior to use.
- 4 Inspect the workplace.**

Know and understand the workplace inspection before going on to the next section.

- 5 Only use the machine as it was intended.

Fundamentals

The workplace inspection helps the operator determine if the workplace is suitable for safe machine operation. It should be performed by the operator prior to moving the machine to the workplace.

It is the operator's responsibility to read and remember the workplace hazards, then watch for and avoid them while moving, setting up and operating the machine.

Workplace Inspection

Be aware of and avoid the following hazardous situations:

- drop-offs or holes
- bumps, floor obstructions or debris
- sloped surfaces
- unstable or slippery surfaces
- overhead obstructions and high voltage conductors
- hazardous locations
- inadequate surface support to withstand all load forces imposed by the machine
- wind and weather conditions
- the presence of unauthorized personnel
- other possible unsafe conditions

Operating Instructions

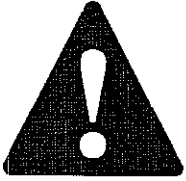

Do Not Operate Unless:

- You learn and practice the principles of safe machine operation contained in this operator's manual.
 - 1 Avoid hazardous situations.
 - 2 Always perform a pre-operation inspection.
 - 3 Always perform function tests prior to use.
 - 4 Inspect the workplace.
 - 5 **Only use the machine as it was intended.**

Fundamentals

The Operating Instructions section provides instructions for each aspect of machine operation. It is the operator's responsibility to follow all the safety rules and instructions in the operator's, safety and responsibilities manuals.

Using the machine for anything other than lifting personnel, along with their tools and materials, to an aerial work site is unsafe and dangerous.

Only trained and authorized personnel should be permitted to operate a machine. If more than one operator is expected to use a machine at different times in the same work shift, they must all be qualified operators and are all expected to follow all safety rules and instructions in the operator's, safety and responsibilities manuals. That means every new operator should perform a pre-operation inspection, function tests, and a work place inspection before using the machine.

OPERATING INSTRUCTIONS

Emergency Stop

Push in the red Emergency Stop button to the off position at the ground or platform controls to stop all machine functions.

Repair any function that operates when the red Emergency Stop button is pushed in.

Selecting and operating the ground controls will override the platform red Emergency Stop button.

Auxiliary Controls

Use auxiliary power if the primary power source fails.

- 1 Turn the key switch to ground or platform control.
- 2 Pull out the red Emergency Stop button to the on position.
- 3 Press down the foot switch when operating the auxiliary controls from the platform.
- 4 Simultaneously hold the auxiliary power switch on and activate the desired function.



The boom, steer and drive functions will operate with auxiliary power.

Operation from Ground

- 1 Turn the key switch to ground control.
- 2 Pull out the red Emergency Stop button to the on position.
- 3 Be sure both battery packs are connected before operating the machine.

To Position Platform

- 1 Hold the function enable switch to either side.
- 2 Move the appropriate toggle switch according to markings on the control panel.



Drive and steer functions are not available from the ground controls.

Machines equipped with Platform Level Control Disable Function: The platform level toggle switch will not operate when the boom is raised past the drive speed limit switch.

OPERATING INSTRUCTIONS

Operation from Platform

- 1 Turn the key switch to platform control.
- 2 Pull out both ground and platform red Emergency Stop buttons to the on position.
- 3 Be sure that both battery packs are connected before operating the machine.

To Position Platform

- 1 Set the boom function speed controller to the desired speed.

Note: Drive and steer functions are not affected by the boom function speed controller.

- 2 Press down the foot switch.
- 3 Move the appropriate toggle switch according to the markings on the control panel.

Machines equipped with Platform Level Control Disable Function: The platform level toggle switch will not operate when the boom is raised past the drive speed limit switch.

To Steer

- 1 Press down the foot switch.
- 2 Turn the steer wheels with the thumb rocker switch located on top of the drive control handle.

Use the color-coded direction triangles on the platform controls and the drive chassis to identify the direction the wheels will turn.

To Drive

- 1 Press down the foot switch.
- 2 Increase speed: Slowly move the drive control handle off center.

Decrease speed: Slowly move the drive control handle toward center.

Stop: Return the drive control handle to center or release the foot switch.

Use the color-coded direction arrows on the platform controls and the drive chassis to identify the direction the machine will travel.

Machine travel speed is restricted when the booms are raised or extended.

Battery condition will affect machine performance.

Drive Enable

Light on indicates that the boom has moved past either non-steer wheel and the drive function has been interrupted.



To drive, hold the drive enable switch up or down and slowly move the drive control handle off center.

Be aware that the machine may move in the opposite direction that the drive and steer controls are moved.

Always use the color-coded direction arrows on the platform controls and the drive chassis to identify the direction the machine will travel.

OPERATING INSTRUCTIONS

Low Voltage Interrupt (if equipped)

Machines equipped with Low Voltage Interrupt will lose primary and secondary boom up functions from the platform when batteries are low.

Machine Not Level Indicator Light (if equipped)



Light on indicates the machine is not level. The tilt alarm will be sounding when this light is on. Move the machine to a firm level surface.

Platform Overload Indicator Light (if equipped)



Light flashing indicates the platform is overloaded and no functions will operate.

Remove weight from the platform until the light goes off.

Fall Protection

Personal fall protection equipment (PFPE) is required when operating this machine.

All PFPE must comply with applicable governmental regulations, and must be inspected and used in accordance with the PFPE manufacturer's instructions.

After Each Use

- 1 Select a safe parking location—firm level surface, clear of obstruction and traffic.
- 2 Lower the boom to the stowed position.
- 3 Rotate the turntable so that the boom is between the non-steerwheels.
- 4 Turn the key switch to the off position and remove the key to secure from unauthorized use.
- 5 Chock the wheels.
- 6 Charge the batteries.

OPERATING INSTRUCTIONS

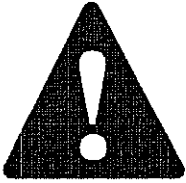
**Battery and Charger Instructions****Observe and Obey:**

- Do not use an external charger or booster battery.
- Charge the battery in a well-ventilated area.
- Use proper AC input voltage for charging as indicated on the charger.
- Use only Genie authorized battery and charger.

To Charge Battery

- 1 Be sure the batteries are connected before charging the batteries.
- 2 Open the battery compartment. The compartment should remain open for the entire charging cycle.
- 3 Remove the battery vent caps and check the battery acid level. If necessary, add only enough distilled water to cover the plates. Do not overfill prior to the charge cycle.
- 4 Replace the battery vent caps.
- 5 Connect the battery charger to a grounded AC circuit.
- 6 Turn the battery charger on.
- 7 The charger will indicate when the battery is fully charged.
- 8 Check the battery acid level when the charging cycle is complete. Replenish with distilled water to the bottom of the fill tube. Do not overfill.

Dry Battery Filling and Charging Instructions

- 1 Remove the battery vent caps and permanently remove the plastic seal from the battery vent openings.
- 2 Fill each cell with battery acid (electrolyte) until the level is sufficient to cover the plates.

Do not fill to maximum level until the battery charge cycle is complete. Overfilling can cause the battery acid to overflow during charging. Neutralize battery acid spills with baking soda and water.

- 3 Install the battery vent caps.
- 4 Charge the battery.
- 5 Check the battery acid level when the charging cycle is complete. Replenish with distilled water to the bottom of the fill tube. Do not overfill.

Transport and Lifting Instructions

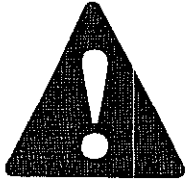

Observe and Obey:

- ☑ Common sense and planning must be applied to control the movement of the machine when lifting it with a crane or forklift.
- ☑ The transport vehicle must be parked on a level surface.
- ☑ The transport vehicle must be secured to prevent rolling while the machine is being loaded.
- ☑ Be sure the vehicle capacity, loading surfaces and chains or straps are sufficient to withstand the machine weight. See the serial plate for the machine weight.
- ☑ The machine must be on a level surface or secured before releasing the brakes.

Free-wheel Configuration for Winching

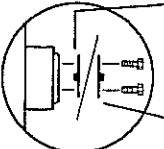
- 1 Chock the wheels to prevent the machine from rolling.
- 2 Release the non-steer wheel brakes by turning over the drive hub disconnect caps. 
- 3 Be sure the winch line is properly secured to the drive chassis tie points and the path is clear of all obstructions.

After the machine is loaded:

- 1 Chock the wheels to prevent the machine from rolling.
- 2 Apply the non-steer wheel brakes by turning over the drive hub disconnect caps.

Towing the Genie Z-30/20N is not recommended. If the machine must be towed, do not exceed 2 mph / 3.2 km/h.

TRANSPORT AND LIFTING INSTRUCTIONS

Securing to Truck or Trailer for Transit

Always chock the machine wheels in preparation for transport.

Turn the key switch to the off position and remove the key before transporting.

Inspect the entire machine for loose or unsecured items.

Securing the Chassis

Use the tie points on the drive chassis for anchoring down to the transport surface.

Use chains or straps of ample load capacity.

Use a minimum of 4 chains.

Adjust the rigging to prevent damage to the chains.

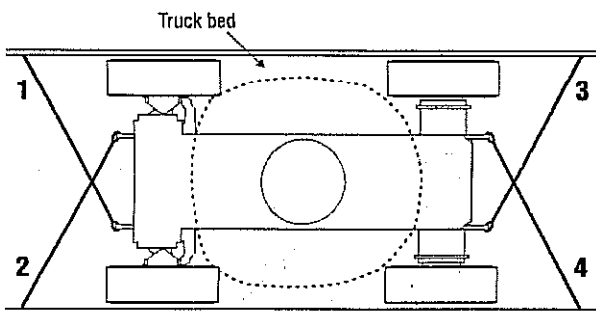
**Securing the Platform**

Make sure the jib and platform are in the stowed position.

Place a block under the edge of the platform beneath the platform entry.

Secure the platform with a nylon strap placed over the platform mount near the platform rotator (see below). Do not use excessive downward force when securing the boom section.

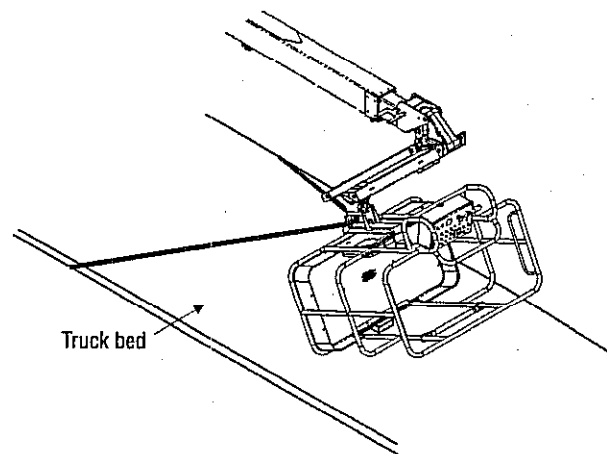

TRANSPORT AND LIFTING INSTRUCTIONS



Observe and Obey:

- Only qualified riggers should rig and lift the machine.
- Be sure the crane capacity, loading surfaces and straps or lines are sufficient to withstand the machine weight. See the serial plate for the machine weight.

Lifting Instructions

Fully lower and retract the boom. Fully lower the jib. Remove all loose items on the machine.

Determine the center of gravity of your machine using the table and the picture on this page.

Attach the rigging only to the designated lifting points on the machine. There are four lifting points on the chassis.

Adjust the rigging to prevent damage to the machine and to keep the machine level.

X Axis	31.19 in	79.2 cm
Y Axis	34.34 in	87.2 cm

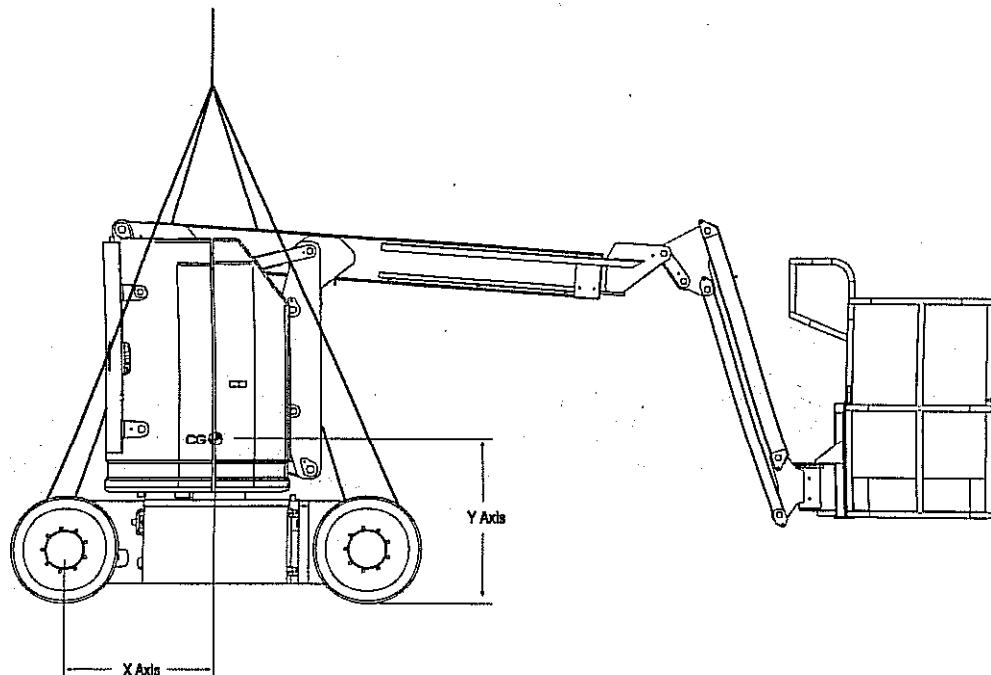

Decals

Inspection for Decals with Words

Determine whether the decals on your machine have words or symbols. Use the appropriate inspection to verify that all decals are legible and in place.

Part No.	Decal Description	Quantity
27564	Danger - Electrocution Hazard	2
28161	Warning - Crushing Hazard	3
28164	Notice - Hazardous Materials	1
28165	Notice - Foot Switch	1
28171	Label - No Smoking	2
28174	Label - Power to Platform, 230V	2
28175	Caution - Compartment Access	1
28176	Notice - Missing Manuals	1
28177	Warning - Platform Rotate	2
28181	Warning - No Step or Ride	1
28235	Label - Power to Platform, 115V	2
28236	Warning - Failure To Read . . .	1
28372	Caution - Component Damage	2
31060	Danger - Tip-over Hazard, Interlock	4
31508	Notice - Power to Charger	1
31785	Notice - Battery Charger Instructions	2
31786	Notice - Battery Connection Diagram	2
31787	Danger - Tip-over, Batteries	2
31788	Danger - Battery/Charger Safety	2
32700	Danger - General Safety	2
33952	Danger - Tilt-Alarm	1
35540	Notice - Operating Instructions, Platform	1
35542	Notice - Lug Nuts	4
37051	Notice - Max Side Force, 150 lbs / 667 N	1
37052	Notice - Maximum Load, 500 lbs / 227 kg	1

Part No.	Decal Description	Quantity
37053	Arrow - Blue	1
37054	Arrow - Yellow	1
37055	Triangle- Blue	2
37056	Triangle - Yellow	2
40434	Label - Lanyard Anchorage	2
43653	Notice - Operating Instructions, Ground	1
43658	Label - Power to Charger, 230V	1
44980	Label - Power to Charger, 115V	1
44981	Label - Air Line to Platform	2
44986	Notice - Max Manual Force, 90 lbs / 400 N	1
52968	Cosmetic - Genie Boom	1
62928	Cosmetic - Genie Z-30/20N	1
62929	Cosmetic - Genie Z-30/20N	2
65171	Label - Circuit Breaker & Status Light	1
72167	Cosmetic - Genie Z-30/20N RJ	1
72081	Platform Control Panel	1
72833	Label - Open	2
82366	Label - Chevron Rykon	1
82592	Ground Control Panel	1
82628	Label - Wheel Load	4

DECALS

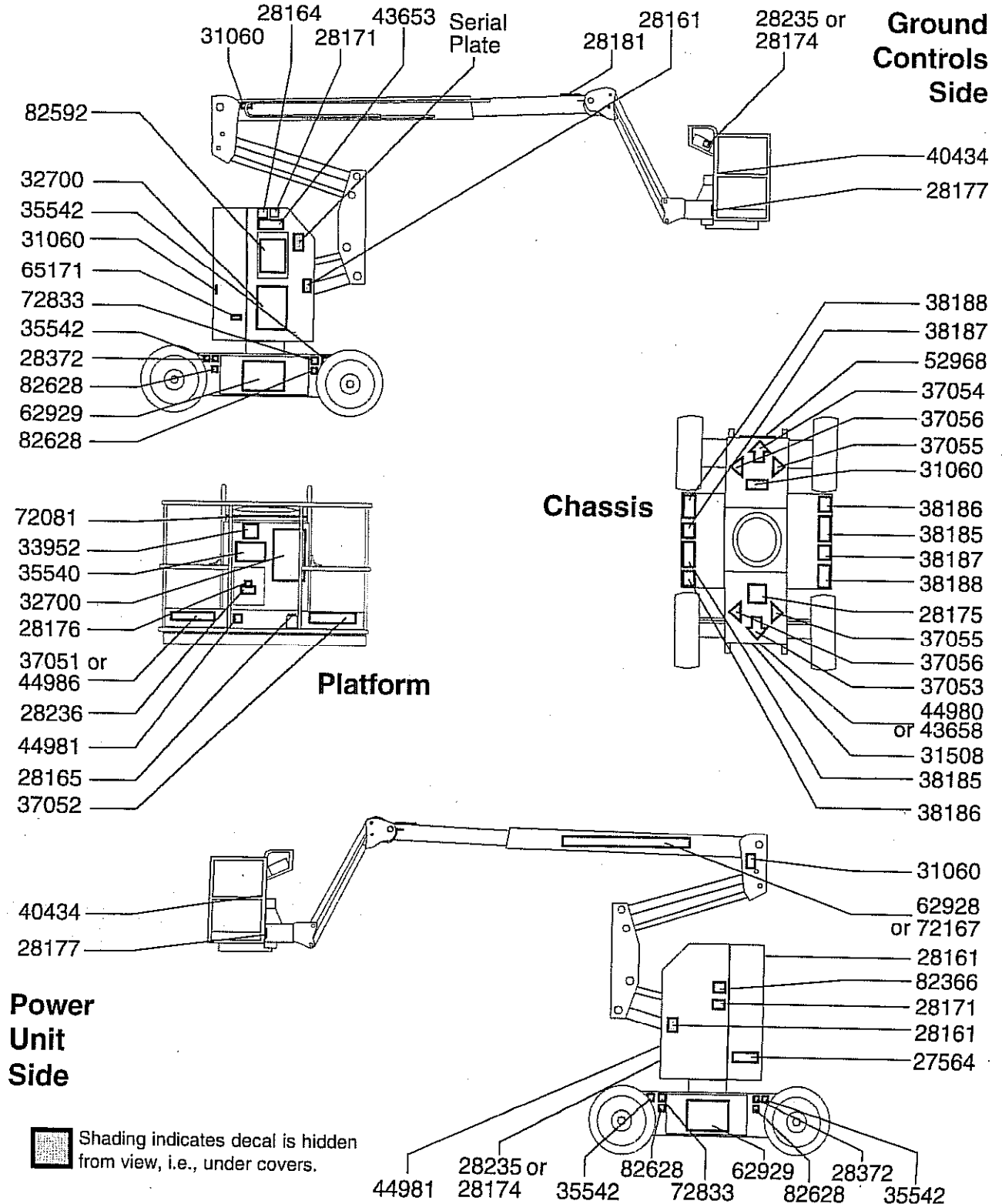

DECALS

Inspection for Decals with Symbols

Determine whether the decals on your machine have words or symbols. Use the appropriate inspection to verify that all decals are legible and in place.

Part No.	Decal Description	Quantity
28174	Label - Power to Platform, 230V	2
28235	Label - Power to Platform, 115V	2
37053	Arrow - Blue	1
37054	Arrow - Yellow	1
37055	Triangle- Blue	2
37056	Triangle - Yellow	2
40434	Label - Lanyard Anchorage	2
43658	Label - Power to Charger, 230V	1
44980	Label - Power to Charger, 115V	1
44981	Label - Air line to Platform	2
52968	Cosmetic - Genie Boom	1
62928	Cosmetic - Genie Z-30/20N	1
62929	Cosmetic - Genie Z-30/20N	2

Part No.	Decal Description	Quantity
72081	Platform Control Panel	1
72167	Cosmetic - Genie Z-30/20N RJ	1
82472	Warning - Crushing Hazard	3
82481	Danger - Battery Safety	2
82487	Label - Operating Instructions	2
82544	Danger - Electrocuting Hazard	2
82548	Warning - Platform Rotate	2
82592	Ground Control Panel	1
82601	Danger - Maximum Capacity, 227 kg	1
82602	Danger - Maximum Manual Force, 667 N	1
82604	Danger - Maximum Manual Force, 400 N	1
82610	Label - Circuit Breaker & Status Light	1
82611	Label - Drive Enable Patch	1
82628	Label - Wheel Load	4

DECALS

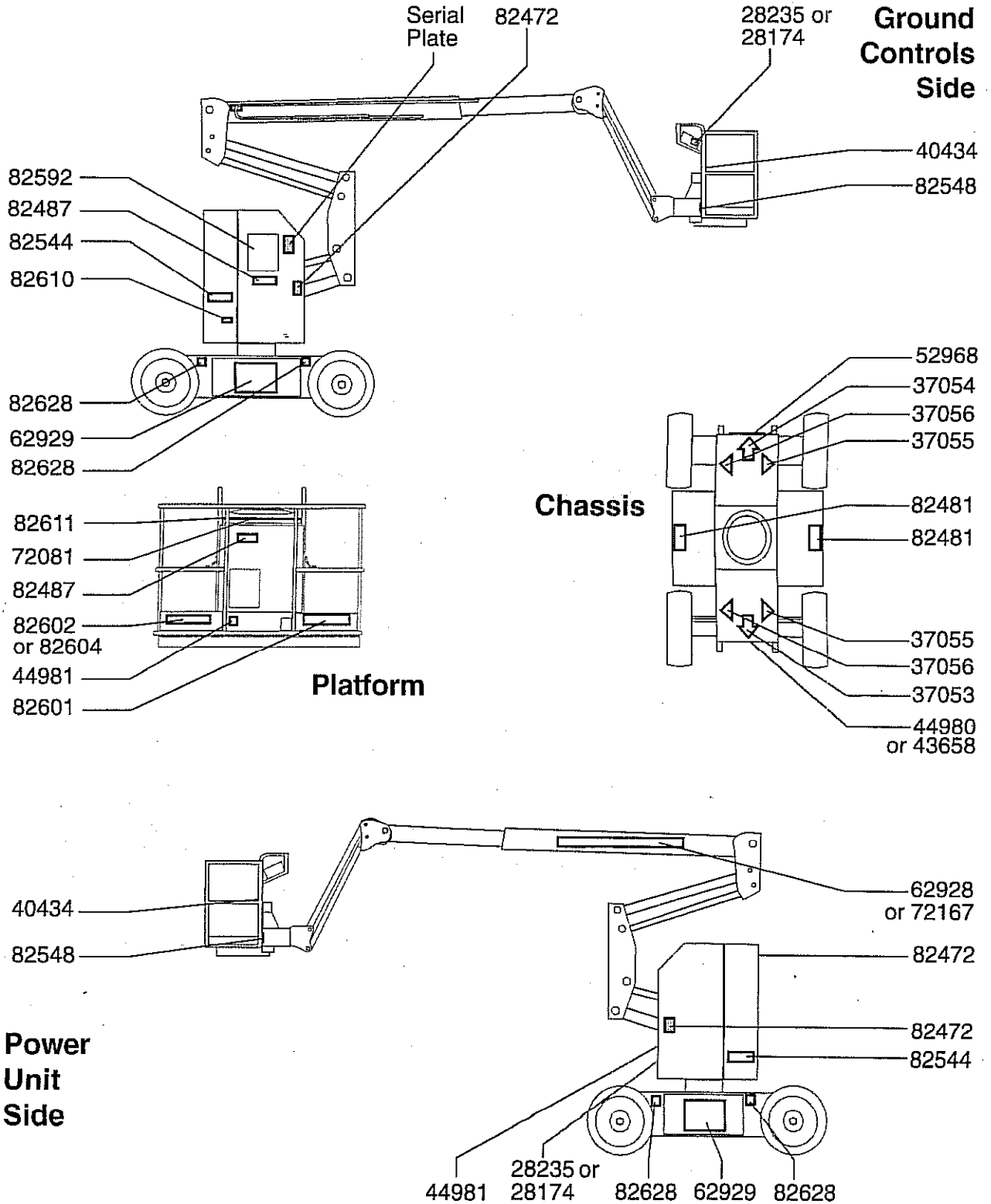

Specifications

Z-30/20 N without rotating jib		
Height, working maximum	36 ft	11 m
Height, platform maximum	30 ft	9.1 m
Height, stowed maximum	6 ft 7 in	2 m
Horizontal reach maximum	21 ft	6.4 m
Width	3 ft 11 in	1.2 m
Length, stowed	16 ft 9 in	5.1 m
Maximum load capacity 46 inch / 1.8 m platform	500 lb	227 kg
Wheelbase	5 ft 2 in	1.6 m
Turning radius (outside)	9 ft 10 in	3.0 m
Turning radius (inside)	5 ft 5 in	1.7 m
Turntable rotation	359°	
Turntable tailswing	0°	
Power source	8 Group-L16, 6V 350AH Batteries	
Controls	24V DC proportional	
Platform dimensions, (length x width)	46 in x 30 in 1.8 m x 76 cm	
Platform leveling	self-leveling	
Platform rotation	180°	
AC outlet in platform	standard	
Hydraulic pressure, maximum (boom functions)	2800 psi 193 bar	
System voltage	48V	
Tire size (solid rubber)	22 x 7 x 17 ³ / ₄ in 56 x 18 x 45 cm	

Gradeability, stowed	25%	
Ground clearance	3 1/2 in	8.9 cm
Weight	See Serial Plate (Machine weights vary with option configurations)	
Airborne noise emissions Maximum sound level at normal operating workstations (A-weighted)	70 dB	

Drive speeds		
Drive speed, stowed	3.3 mph 40 ft/8.2 sec	5.3 km/h 12.2 m/8.2 sec
Drive speed, booms raised or extended	0.6 mph 40 ft/40 sec	1.0 km/h 12.2 m/40 sec

Floor Loading Information		
GVW+Rated Load	15,000 lbs	6804 kg
Axle load, maximum	10,100 lbs	4580 kg
Wheel load, maximum	6400 lbs	2902 kg
Localized pressure per tire	103 psi	7.24 kg/cm ² 710 kPa
Occupied pressure	547 psf	26.71 kPa

Note: Floor loading information is approximate and does not incorporate different option configurations. It should be used only with adequate safety factors.

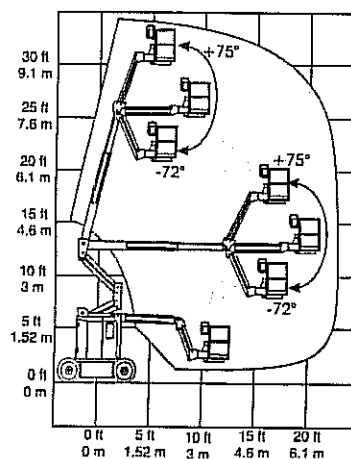

Continuous improvement of our products is a Genie policy. Product specifications are subject to change without notice or obligation.

SPECIFICATIONS

Z-30/20 N with rotating jib		
Height, working maximum	35 ft 2 in	10.7 m
Height, platform maximum	29 ft 2 in	8.8 m
Height, stowed maximum	6 ft 7 in	2 m
Horizontal reach maximum	21 ft	6.4 m
Width	3 ft 11 in	1.2 m
Length, stowed	17 ft 6 in	5.3 m
Maximum load capacity 46 inch / 1.8 m platform	500 lb	227 kg
Wheelbase	5 ft 2 in	1.6 m
Turning radius (outside)	9 ft 10 in	3.0 m
Turning radius (inside)	5 ft 5 in	1.7 m
Turntable rotation	359°	
Turntable tailswing	0°	
Power source	8 Group-L16, 6V 350AH Batteries	
Controls	24V DC proportional	
Platform dimensions, (length x width)	46 in x 30 in 1.8 m x 76 cm	
Platform leveling	self-leveling	
Platform rotation	180°	
Jib rotation	200°	
AC outlet in platform	standard	
Hydraulic pressure, maximum (boom functions)	2800 psi 193 bar	
System voltage	48V	
Tire size (solid rubber)	22 x 7 x 17 ³ / ₄ in 56 x 18 x 45 cm	

Gradeability, stowed	25%	
Ground clearance	3 ¹ / ₂ in	8.9 cm
Weight (Machine weights vary with option configurations)	See Serial Plate	
Airborne noise emissions Maximum sound level at normal operating workstations (A-weighted)	70 dB	

Drive speeds

Drive speed, stowed	3.3 mph	5.3 km/h
	40 ft/8.2 sec	12.2 m/8.2 sec
Drive speed, booms raised or extended	0.6 mph	1.0 km/h
	40 ft/40 sec	12.2 m/40 sec

Floor Loading Information

GVW+Rated Load	15,100 lbs	6849 kg
Axle load, maximum	11,200 lbs	5079 kg
Wheel load, maximum	6450 lbs	2925 kg
Localized pressure per tire	103 psi	7.24 kg/cm ² 710 kPa
Occupied pressure	551 psf	26.37 kPa

Note: Floor loading information is approximate and does not incorporate different option configurations. It should be used only with adequate safety factors.

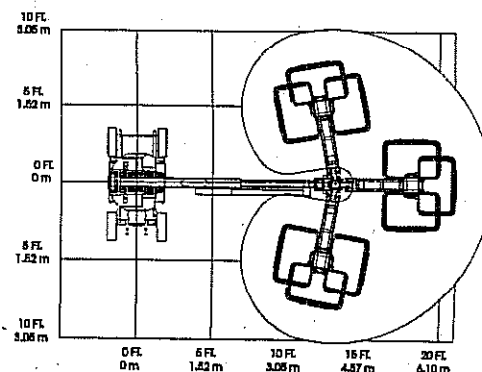

Continuous improvement of our products is a Genie policy. Product specifications are subject to change without notice or obligation.

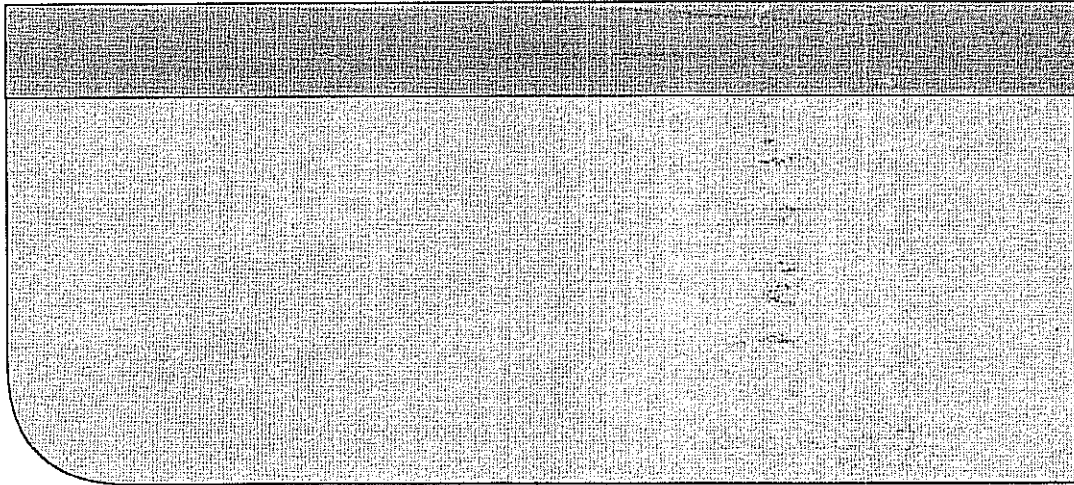

Genie Scandinavia
Phone +46 31 3409612
Fax +46 31 3409613

Genie France
Phone +33 (0)2 37 26 09 99
Fax +33 (0)2 37 26 09 98

Genie Iberica
Phone +34 93 579 5042
Fax +34 93 579 5059

Genie Germany
Phone +49 (0)4202 88520
Fax +49 (0)4202 8852-20

Genie U.K.
Phone +44 (0)1476 584333
Fax +44 (0)1476 584334

Genie Mexico City
Phone +52 55 5666 5242
Fax +52 55 5666 3241

Genie North America
Phone 425.881.1800
Toll Free USA and Canada
 800.536.1800
Fax 425.883.3475

Genie Australia Pty Ltd.
Phone +61 7 3375 1660
Fax +61 7 3375 1002

Genie China
Phone +86 21 53852570
Fax +86 21 53852569

Genie Malaysia
Phone +65 98 480 775
Fax +65 67 533 544

Genie Japan
Phone +81 3 3453 6082
Fax +81 3 3453 6083

Genie Korea
Phone +82 25 587 267
Fax +82 25 583 910

Genie Brasil
Phone +55 11 41 665 755
Fax +55 11 41 665 754

Genie Holland
Phone +31 10 220 7911
Fax +31 10 220 6642

by
 partners
 D